



COMPANY OVERVIEW 2014



Competence areas



SYSTEM INTEGRATOR

SW HOUSE

SERVICE AND AFTER SALES

REVAMPING

M2M



- ▶ Planning for safety systems and global management for lifting machines
- ▶ Studying and processing of client technical specifications
- ▶ Solutions for industrial automation
- ▶ Handling hydraulics and electrical engine power
- ▶ CAN-BUS, CANOPEN, J1939 interface.
- ▶ Sensors and machines logic control

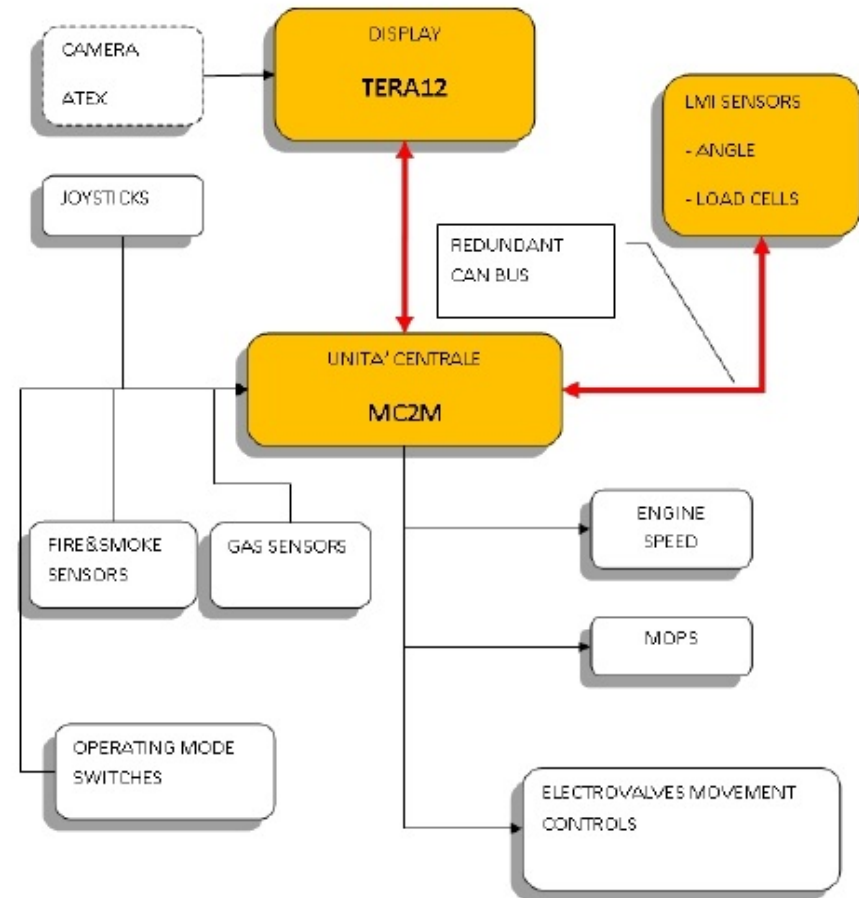

- SYSTEM INTEGRATOR
- SW HOUSE
- SERVICE AND AFTER SALES
- CRANE REVAMPING
- M2M

▶ Systems for:

- ▶ Mobile crane
- ▶ Harbour crane
- ▶ Reach stacker
- ▶ Forklift
- ▶ Rail road Loader
- ▶ Knuckle crane
- ▶ Lattice boom crane
- ▶ Telescopic handler
- ▶ Tower crane
- ▶ Marine crane
- ▶ Oil rig crane
- ▶ Drilling machine

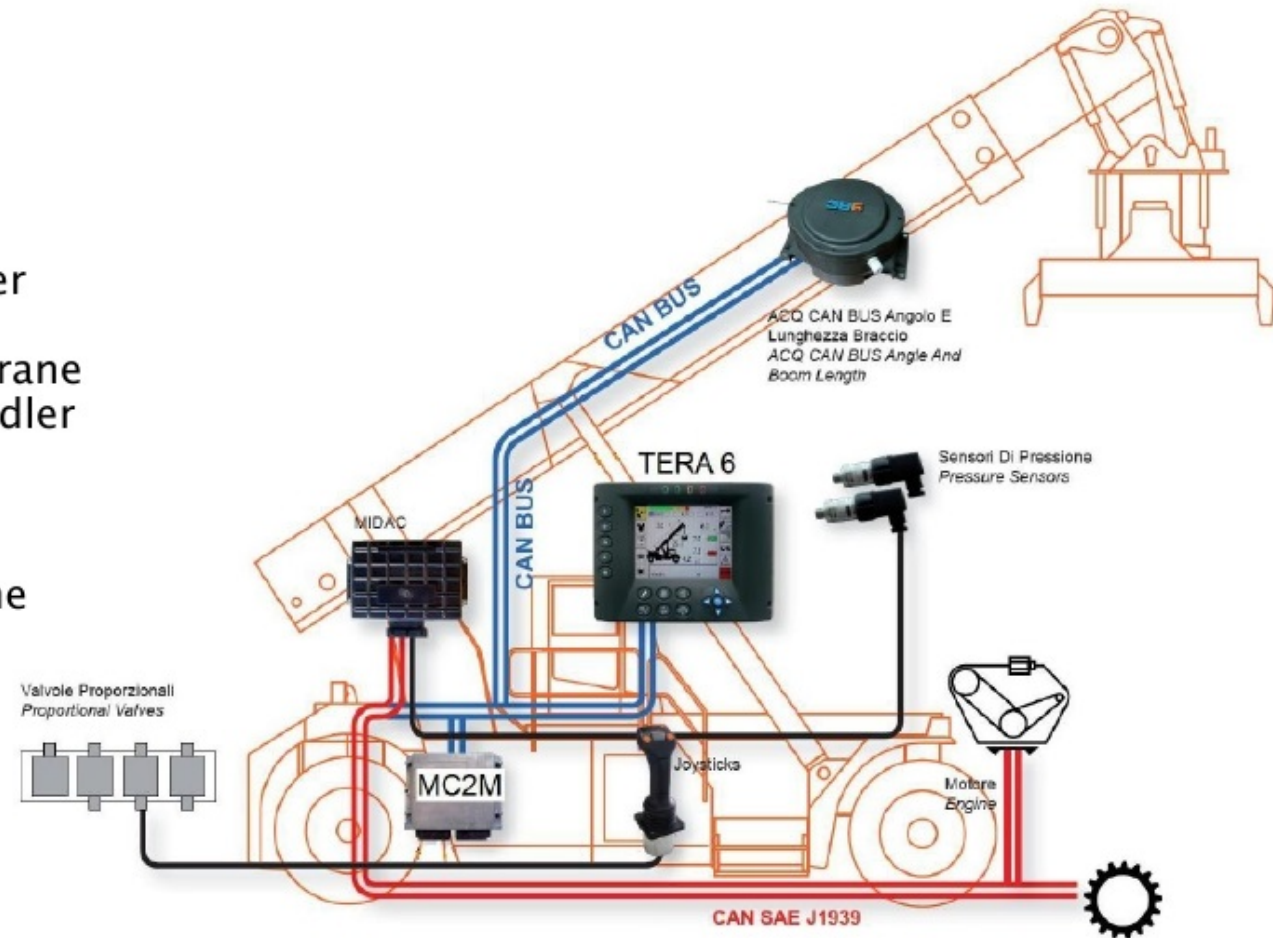

- SYSTEM INTEGRATOR
- SW HOUSE
- SERVICE AND AFTER SALES
- CRANE REVAMPING
- M2M

3BMust International S.r.l.
Sistemi Sicurezza ed
Automazione Industriale

HW supply:

- ▶ Touch screen display
- ▶ Central unit with redundant processor
- ▶ Sensors
- ▶ Cabling engineering
- ▶ Dedicated systems for ATEX ex proof area



3BMust International S.r.l.
Sistemi Sicurezza ed
Automazione Industriale

HMI Human Machine Interface graphic design

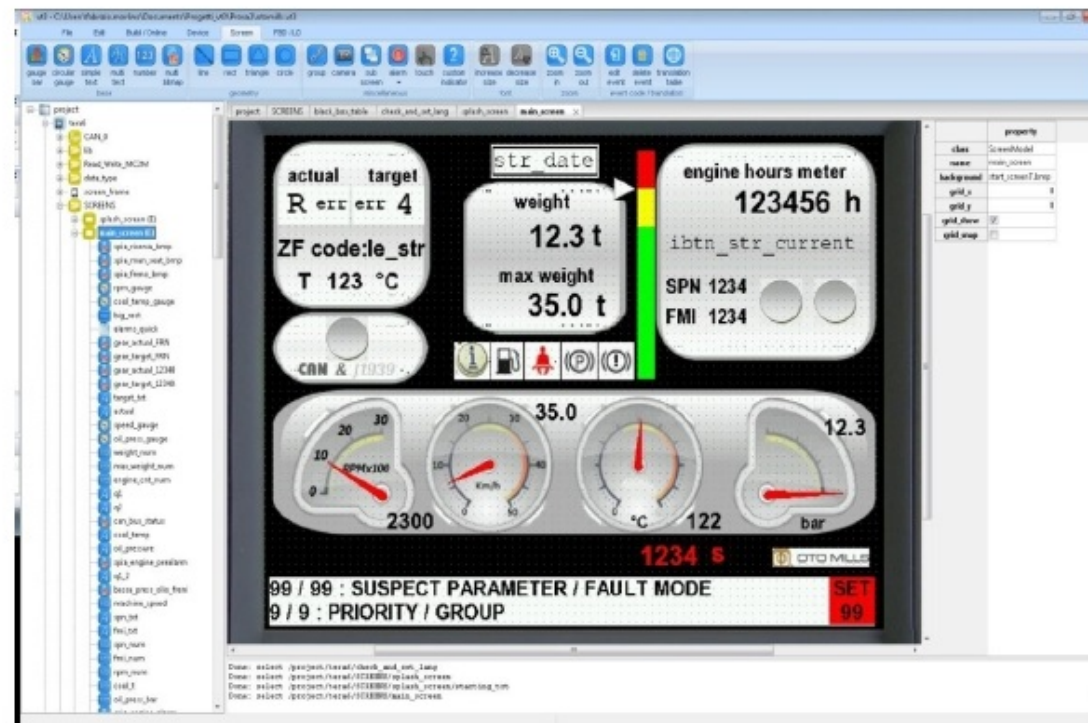

- SYSTEM INTEGRATOR
- SW HOUSE
- SERVICE AND AFTER SALES
- CRANE REVAMPING
- M2M

3BMust International S.r.l.
Sistemi Sicurezza ed
Automazione Industriale

- ▶ Project developed on VT3 platform

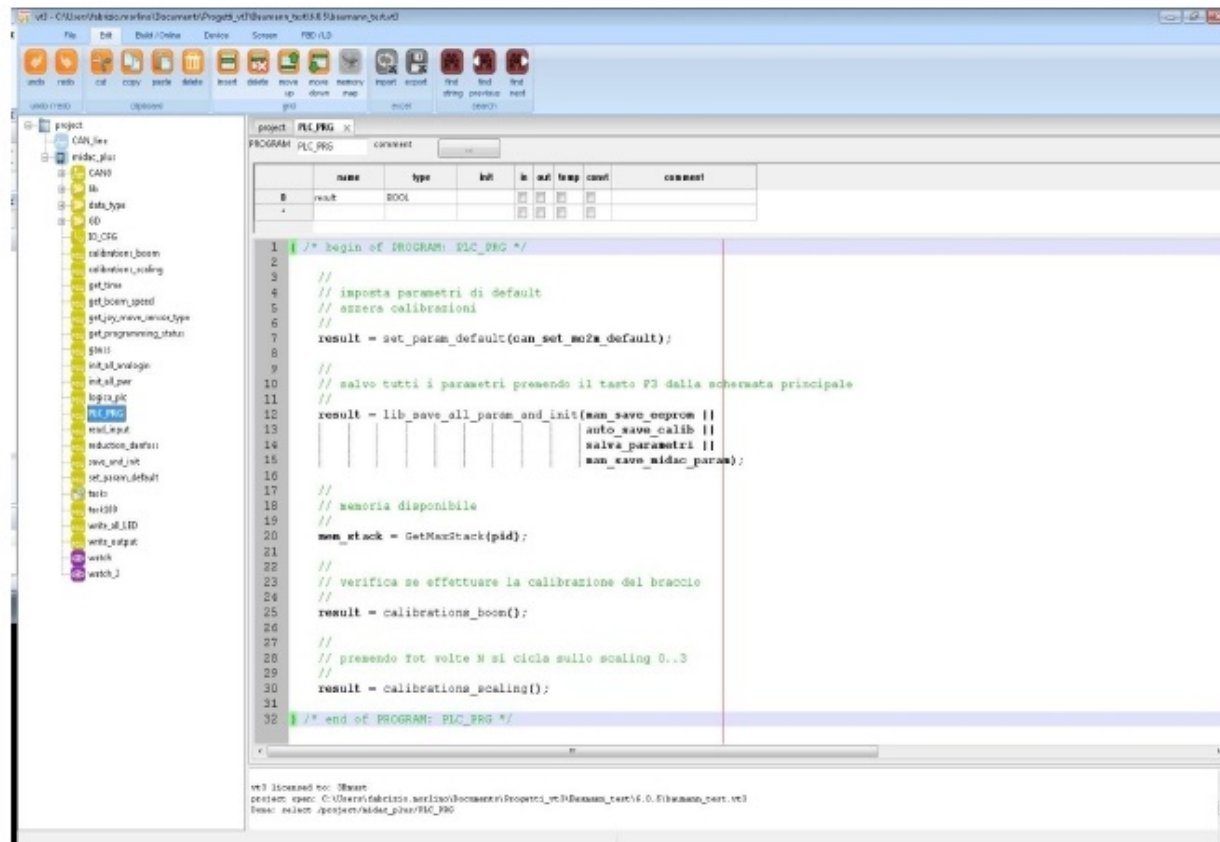

name	type	bit	in	out	temp	conv	comment
result	BOOL						

```

1 /* Begin of PROGRAM: PLC_PRG */
2
3 //
4 // imposta parametri di default
5 // azzerà calibrations
6
7 result = set_param_default(can_set_mo2* default);
8
9 //
10 // salvo tutti i parametri premendo il tasto F3 dalla schermata principale
11 //
12 result = lib_save_all_param_and_init(mem_save_ompron ||
13 | auto_save_calib ||
14 | salva_parametri ||
15 | mem_save_midac_param);
16
17 //
18 // memoria disponibile
19 //
20 mem_stack = GetMaxStack(pid);
21
22 //
23 // verifica se effettuare la calibrations del braccio
24 //
25 result = calibrations_boom();
26
27 //
28 // premendo tot volte N si cicla sullo scaling 0..3
29 //
30 result = calibrations_scaling();
31
32 /* end of PROGRAM: PLC_PRG */
  
```

- SYSTEM INTEGRATOR
- SW HOUSE
- SERVICE AND AFTER SALES
- CRANE REVAMPING
- M2M

3BMust International S.r.l.
Sistemi Sicurezza ed
Automazione Industriale



Service and After Sales

- ▶ Service & Maintenance Worldwide
- ▶ After sales spare parts and services
- ▶ Technical assistance contracts



- SYSTEM INTEGRATOR
- SW HOUSE
- SERVICE AND AFTER SALES
- CRANE REVAMPING
- M2M

3BMust International S.r.l.
Sistemi Sicurezza ed
Automazione Industriale

- ▶ Kit LMI (Load Moment Indicator) for lifting machines
- ▶ Designed EN13000 EN954 directive electronic solution

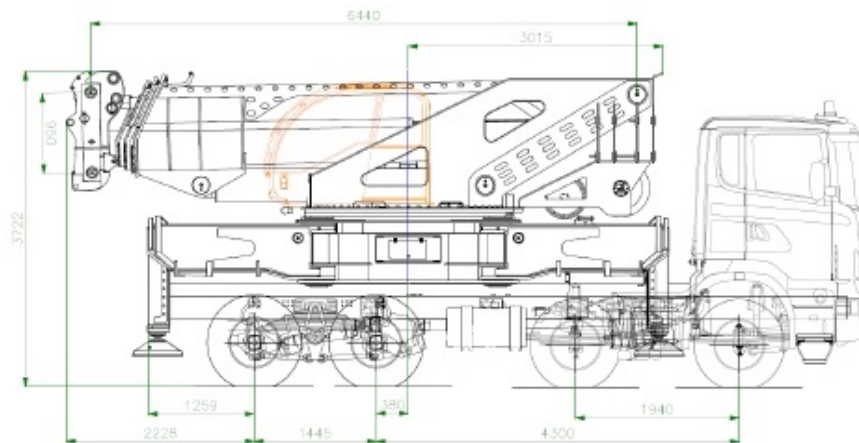

- SYSTEM INTEGRATOR
- SW HOUSE
- SERVICE AND AFTER SALES
- CRANE REVAMPING
- M2M

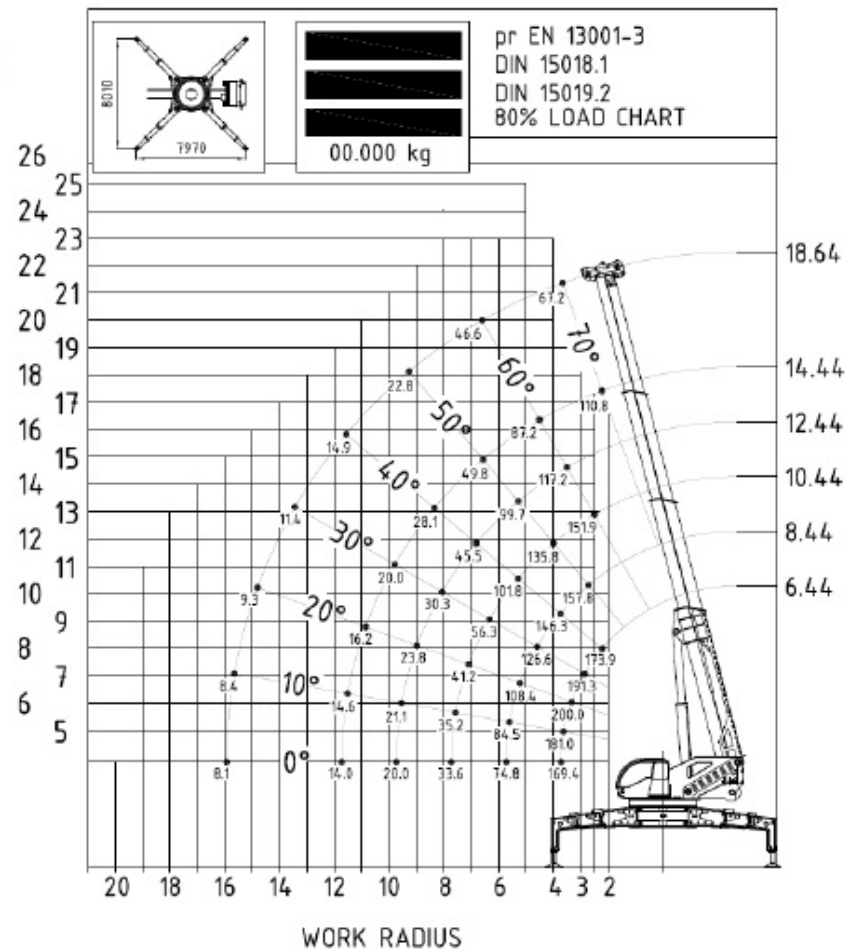

3BMust International S.r.l.
Sistemi Sicurezza ed
Automazione Industriale

- Distance control of machine functional range, allowing updating and maintenance process
- Connection through LAN net, WIFI or UMTS/GPRS
- System synoptic with visualization of main functional parameters
- Protected access license.
- Compatibility with Windows applications.
- Direct connection of data collection (without server).



PC through WIFI

PC through internet

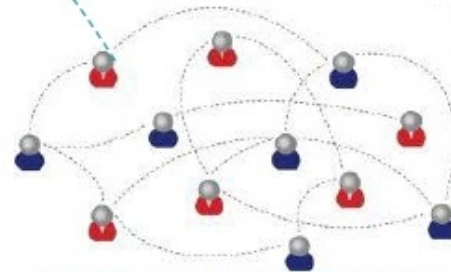

3BMust International S.r.l.
Sistemi Sicurezza ed
Automazione Industriale

- SYSTEM INTEGRATOR
- SW HOUSE
- SERVICE AND AFTER SALES
- REVAMPING
- M2M



Our Success : MEP Pellegrini



London (UK):

MEP Pellegrini has been using with great results and affidability the global control electronic system provided by 3Bmust for the control and maintenance cranes installed on the restraint barrier of the Thames river.

The supply scheduled for 7 GN 15/3 SPECIAL cranes started in April 2011 with the pre-series crane, that passed with success tests of the United Kingdom Environment Agency, and will be ended in May 2012.



Eurogru Amici:
Crane 200.23 capacity 200 tons



SCM:
Crane SA4100 capacity 100 tons

TCM:
Italian army military crane



C 400 M



Special applications

Global control and safety Electronic system for tower crane capacity 1000tons

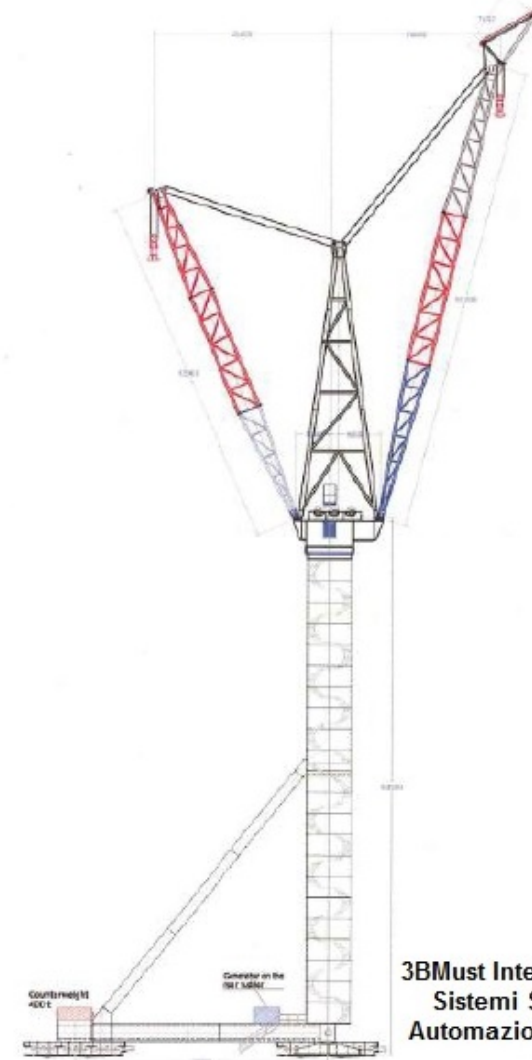

3Bmust International S.r.l
Sistemi Sicurezza ed
Automazione Industriale



International dealers

- ▶ ALGERIA : Eurl Sm Maintenance – Baba Hassen
- ▶ ARABIA SAUDITA: Utesco – Universal Technical Service Company – Dammam
- ▶ BRASILE : 3b6 Sistemas Eletronicos Industrias Ltd – Campinas San Paolo
- ▶ CILE : Integracion De Sistemas S.A. – San Miguel – Santiago
- ▶ DUBAI: Multimech Heavy Equipment – Dubai
- ▶ EGITTO: Egyptian Maintenance Company – Cairo
- ▶ GRECIA : General Agencies S.A – Kallithea Atene
- ▶ PORTOGALLO : Almovi Maquinas e Equipamentos Lda – Alcabideche



Customers portfolio

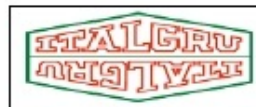

3BMust International S.r.l.
Sistemi Sicurezza ed
Automazione Industriale



3Bmust International Srl

Sede legale: Via Dante n.14 - 26100 CREMONA (CR)
Sede operativa: Via P.Pastorino n.38/44 - 16162 Genova Italy
P.IVA e C.F. 02425300205
Tel: +39.010.85.96.800 Fax: +39.010.85.96.899

3BMust International S.r.l.
Sistemi Sicurezza ed
Automazione Industriale